

John Michael  
Designs

7080 Maya  
2 Cushion Version

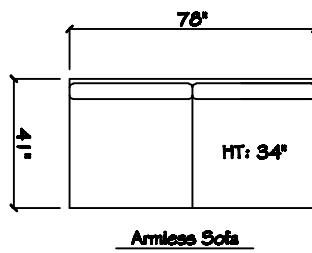
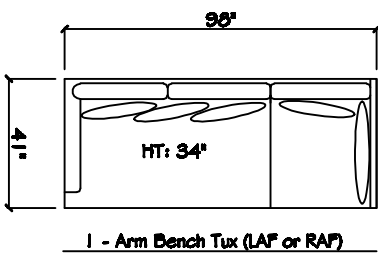
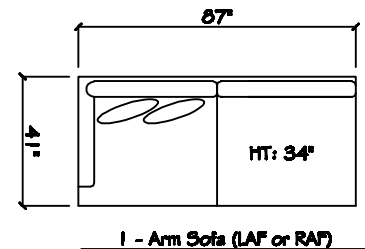
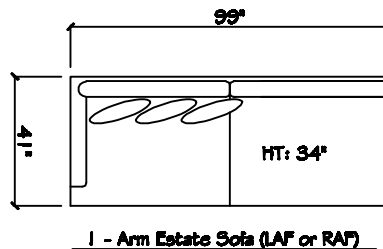
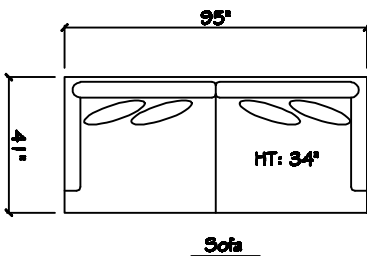
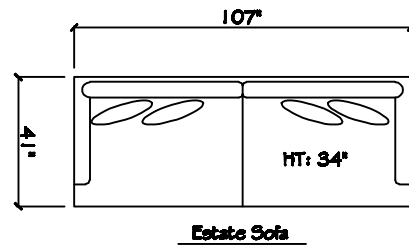
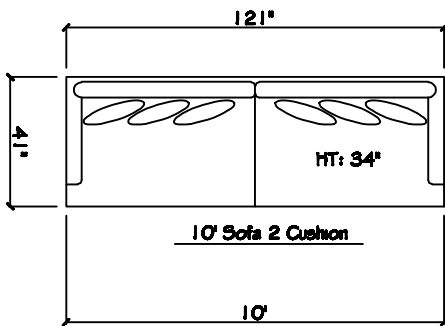

Dimensions are approximate with a variance of 1" to 3"